



# Operator's Manual

## V-Series Units with Direct Smart Reefer

V-100, V-200, V-200s, V-300, V-500, V-600, V-800, V-1000 and Spectrum units

Revision B

# Introduction

This manual is published for informational purposes only and the information furnished herein should not be considered as all-inclusive or meant to cover all contingencies. If more information is required, consult your Thermo King Service Directory for the location and telephone number of the local dealer.

**Thermo King's warranty shall not apply to any equipment which has been "so installed, maintained, repaired or altered as, in the manufacturer's judgment, to affect its integrity."**

***Manufacturer shall have no liability to any person or entity for any personal injury, property damage or any other direct, indirect, special, or consequential damages whatsoever, arising out of the use of this manual or any information, recommendations or descriptions contained herein. The procedures described herein should only be undertaken by suitably qualified personnel. Failure to implement these procedures correctly may cause damage to the Thermo King unit or other property or personal injury.***

There is nothing complicated about operating and maintaining your Thermo King unit, but a few minutes studying this manual will be time well spent.

Performing pre-trip checks and enroute inspections on a regular basis will minimize operating problems. A regular maintenance program will also help to keep your unit in top operating condition. If factory recommended procedures are followed, you will find that you have purchased the most efficient and dependable temperature control system available.

All service requirements, major and minor, should be handled by a Thermo King dealer for four very important reasons:

- They are equipped with the factory recommended tools to perform all service functions.
- They have factory trained and certified technicians.
- They have genuine Thermo King replacement parts.
- The warranty on your new unit is valid only when the repair and replacement of component parts is performed by an authorized Thermo King dealer.

## Software License

The product includes software that is licensed under a non-exclusive, non-sublicensable, terminable and limited license to use the software as installed

on the product for its intended purpose. Any removal, reproduction, reverse engineering, or other unauthorized use of the software is strictly prohibited. Hacking the product or installing unapproved software may void the warranty. The owner or operator shall not reverse engineer, decompile, or disassemble the software, except and only to the extent that such activity is expressly permitted by applicable law notwithstanding this limitation. The product may include third party software separately licensed as specified in any documentation accompanying the product or in an about screen on a mobile application or website that interfaces with the product. You are obliged to complete the declaration for “THERMO KING EQUIPMENT SOFTWARE LICENSE AGREEMENT” before you put your unit in operation. This is located in your language at the following location:<https://www.emea-user-manuals.thermoking.com>

## Emergency Assistance

Thermo Assistance is a multi-lingual communication tool designed to put you in direct contact with an authorized Thermo King dealer.

**Thermo Assistance should only be contacted for breakdown and repair assistance.**

To use this system, you need the following information before you call: (phone charges will apply)

- Contact Phone Number
- Type of TK Unit
- Thermostat Temperature Setting
- Ambient temperature
- Probable Cause of Fault
- Warranty Details of the Unit
- Payment Details for the Repair

Leave your name and contact number and a Thermo Assistance Operator will call you back. At this point you can give details of the service required and the repair will be organized.

No payment at point of repair for customers with a ThermoKare service contract or with a guaranty of payment from their Thermo King home-dealer



Belgium	+32 270 01 735
Denmark	+45 38 48 76 94
France	+33 171 23 05 03
Germany	+49 695 00 70 740
Italy	+39 02 69 63 32 13
Spain	+34 914 53 34 65
The Netherlands	+31 202 01 51 09
United Kingdom	+44 845 85 01 101
Kazakhstan	+7 7273458096
Russia	+7 4992718539
Others	+32 270 01 735

BEA26\*

## General Inquires and Unit Maintenance

For general inquiries please contact your local Thermo King dealer.

Go to [www.europe.thermoking.com](http://www.europe.thermoking.com) and select dealer locator for your local Thermo King dealer.

Or refer to the Thermo King Service Directory for contact information.



## Customer Satisfaction Survey

Let your voice be heard!

Your feedback will help improve our manuals. The survey is accessible through any internet-connected device with a web browser.

Scan the Quick Response (QR) code or click [Technical Publications EMEA Feedback](#)



# Table of Contents

<b>Safety Precautions</b> .....	<b>9</b>
Danger, Warning, Caution, and Notice .....	9
General Safety Practices .....	10
Automatic Start/Stop Operation .....	12
Battery Installation and Cable Routing .....	12
Refrigerant .....	14
Refrigerant Oil .....	16
First Aid .....	16
Safety Decals .....	18
Service .....	18
Operation .....	19
High Voltage .....	19
Condenser and Evaporator Fans .....	19
Remote Start of the Unit .....	20
Refrigerant .....	21
Type Certification .....	22
<b>Unit Description</b> .....	<b>23</b>
Standard Unit Features .....	24
Options .....	24
System Components .....	24
Compressor(s) .....	24
Condenser .....	25
Evaporator .....	25
Electronic Control System .....	26
Description .....	26
Unit Controls .....	28
Standby Operation (Models 20 and 50 Only) .....	29
Electrical System .....	31

Fuses .....	31
Pharma .....	34
<b>Operating Instructions .....</b>	<b>36</b>
General Operation .....	36
Starting the Unit .....	37
Engine Operation .....	37
Electric Standby Operation .....	37
Standard Display .....	38
Single Temperature Units .....	38
Multi-Temperature Units .....	38
Entering Setpoint Temperature .....	39
Single Temperature Units .....	39
Multi-Temperature Units .....	39
Compartment Selection .....	41
Initiating the Evaporator Manual Defrost Cycle .....	43
Initiating the Condenser Manual Defrost Cycle (reverse cycle units only) .....	44
Alarms .....	46
Manual Start .....	46
Auto Start .....	46
Buzzers .....	47
Alarm Code Descriptions .....	48
Clearing Alarm Codes .....	49
Viewing Information Screens .....	50
Main Menu .....	50
Hourmeter Menu .....	50
<b>Loading and Inspection Procedures .....</b>	<b>51</b>

**Table of Contents**

---

Post-Start Inspection .....	51
Loading Procedure .....	51
Post Load Procedure .....	51
<b>Specifications .....</b>	<b>53</b>
Refrigeration System .....	53
Compressor .....	53
Electrical Control System .....	53
Electric Motor (Model 50) .....	58
TrackKing .....	59
<b>Warranty .....</b>	<b>60</b>
<b>Inspection and Service Intervals .....</b>	<b>61</b>
Weekly Pre-Trip Checks .....	61
Weekly Pretrip Inspection .....	61
Weekly Post-Trip Checks .....	62
Inspection and Service Schedules .....	63
Service Record .....	63
Preventative Maintenance .....	63
<b>Serial Number Locations .....</b>	<b>65</b>
<b>Recover Refrigerant .....</b>	<b>68</b>

# Safety Precautions

## Danger, Warning, Caution, and Notice

Thermo King® recommends that all service be performed by a Thermo King dealer and to be aware of several general safety practices.

Safety advisories appear throughout this manual as required. Your personal safety and the proper operation of this unit depend upon the strict observance of these precautions. The four types of advisories are defined as follows:

### **⚠ DANGER**

#### **Hazard!**

Indicates an imminently hazardous situation which, if not avoided, will result in death or serious injury.

### **⚠ WARNING**

#### **Hazard!**

Indicates a potentially hazardous situation which, if not avoided, could result in death or serious injury.

### **⚠ CAUTION**

#### **Hazard!**

Indicates a potentially hazardous situation which, if not avoided, could result in minor or moderate injury and unsafe practices.

### **NOTICE**

#### **Hazard!**

Indicates a situation that could result in equipment or property-damage only accidents.

## General Safety Practices



### **⚠ DANGER**

#### **Risk of Injury!**

Keep hands and loose clothing clear of fans and belts at all times when the unit is operating with the doors open.

### **⚠ WARNING**

#### **Personal Protective Equipment (PPE) Required!**

A battery can be dangerous. Lithium Ion batteries are potentially hazardous. The combustion gas from these batteries is toxic and can present a serious FIRE HAZARD if damaged, defective or improperly used. A battery stores enough electricity to burn you if it discharges quickly. Always wear goggles or safety glasses and personal protective equipment when working with a battery. Do not replace the battery with any type other than the one approved by Thermo King for this unit.

### **⚠ WARNING**

#### **Risk of Injury!**

Do not apply heat to a closed cooling system. Before applying heat to a cooling system, drain it. Then flush it with water and drain the water. Antifreeze contains water and ethylene glycol. The ethylene glycol is flammable and can ignite if the antifreeze is heated enough to boil off the water.

### **⚠ WARNING**

#### **Risk of Injury!**

Temperatures above 120 degrees F (50 degrees C) can cause serious burns. Use an infrared thermometer or other temperature measuring device before touching any potentially hot surfaces.

**▲ CAUTION**

**Sharp Edges!**

Exposed coil fins can cause lacerations. Service work on the evaporator or condenser coils should only be accomplished by a certified Thermo King technician.

## Automatic Start/Stop Operation



### ⚠ CAUTION

#### Risk of Injury!

The unit can start and run automatically any time the unit is turned on. Turn the unit On/Off switch Off before doing inspections or working on any part of the unit. Please note that only Qualified and Certified personnel should attempt to service your Thermo King unit.

## Battery Installation and Cable Routing



### ⚠ WARNING

#### Hazard of Explosion!

An improperly installed battery could result in a fire, explosion, or injury. A Thermo King approved battery must be installed and properly secured to the battery tray.

### ⚠ WARNING

#### Hazard of Explosion!

Improperly installed battery cables could result in a fire, explosion, or injury. Battery cables must be installed, routed, and secured properly to prevent them from rubbing, chaffing, or making contact with hot, sharp, or rotating components.



**⚠ WARNING**

**Fire Hazard!**

Do not attach fuel lines to battery cables or electrical harnesses. This has the potential to cause a fire and could cause serious injury or death.



**⚠ WARNING**

**Personal Protective Equipment (PPE) Required!**

A battery can be dangerous. A battery contains a flammable gas that can ignite or explode. A battery stores enough electricity to burn you if it discharges quickly. A battery contains battery acid that can burn you. Always wear goggles or safety glasses and personal protective equipment when working with a battery. If you get battery acid on you, immediately flush it with water and get medical attention.

**⚠ WARNING**

**Hazard of Explosion!**

Always cover battery terminals to prevent them from making contact with metal components during battery installation. Battery terminals grounding against metal could cause the battery to explode.

**⚠ CAUTION**

**Hazardous Service Procedures!**

Set all unit electrical controls to the OFF position before connecting battery cables to the battery to prevent unit from starting unexpectedly and causing personal injury.

**NOTICE**

**Equipment Damage!**

Do not connect other manufacturer's equipment or accessories to the unit or to the TK Batteries unless approved by Thermo King. Failure to do so can result in severe damage to equipment and void the warranty.

## Refrigerant



Although fluorocarbon refrigerants are classified as safe, use caution when working with refrigerants or in areas where they are being used.

### **▲ DANGER**

#### **Hazardous Gases - Personal Protective Equipment (PPE) Required!**

Refrigerant in the presence of an open flame, spark, or electrical short produces toxic gases that are severe respiratory irritants which can cause serious injury or possible death. When working with or around hazardous chemicals, ALWAYS refer to appropriate Material Data Safety Sheets (MSDS) and OSHA/GHS (Global Harmonized System of Classification and Labelling of Chemicals) guidelines for information on allowable personal exposure levels, proper respiratory protection, and handling instructions.

### **▲ DANGER**

#### **Refrigerant Vapor Hazard!**

Do not inhale refrigerant. Use caution when working with refrigerant or a refrigeration system in any confined area with a limited air supply. Refrigerant displaces air and can cause oxygen depletion, resulting in suffocation and possible death. When working with or around hazardous chemicals, ALWAYS refer to appropriate Material Data Safety Sheets (MSDS) and OSHA/GHS (Global Harmonized System of Classification and Labelling of Chemicals) guidelines for information on allowable personal exposure levels, proper respiratory protection, and handling instructions.

**⚠ WARNING**

**Personal Protective Equipment (PPE) Required!**

Refrigerant in a liquid state evaporates rapidly when exposed to the atmosphere, freezing anything it contacts. Wear butyl lined gloves and other clothing and eye wear when handling refrigerant to help prevent frostbite. When working with or around hazardous chemicals, ALWAYS refer to appropriate Material Data Safety Sheets (MSDS) and OSHA/GHS (Global Harmonized System of Classification and Labelling of Chemicals) guidelines for information on allowable personal exposure levels, proper respiratory protection, and handling instructions.

## Refrigerant Oil



Observe the following precautions when working with or around refrigerant oil:

### **⚠ WARNING**

#### **Personal Protective Equipment (PPE) Required!**

Protect your eyes from contact with refrigerant oil. The oil can cause serious eye injuries. Protect skin and clothing from prolonged or repeated contact with refrigerant oil. To prevent irritation, wash your hands and clothing thoroughly after handling the oil. Rubber gloves are recommended. When working with or around hazardous chemicals, ALWAYS refer to appropriate Material Data Safety Sheets (MSDS) and OSHA/GHS (Global Harmonized System of Classification and Labelling of Chemicals) guidelines for information on allowable personal exposure levels, proper respiratory protection, and handling instructions.

## First Aid

### REFRIGERANT

- **Eyes:** For contact with liquid, immediately flush eyes with large amounts of water and get prompt medical attention.
- **Skin:** Flush area with large amounts of warm water. Do not apply heat. Remove contaminated clothing and shoes. Wrap burns with dry, sterile, bulky dressing to protect from infection. Get prompt medical attention. Wash contaminated clothing before reuse.
- **Inhalation:** Move victim to fresh air and use Cardio Pulmonary Resuscitation (CPR) or mouth-to-mouth resuscitation to restore breathing, if necessary. Stay with victim until emergency personnel arrive.
- **Frost Bite:** In the event of frost bite, the objectives of First Aid are to protect the frozen area from further injury, warm the affected area rapidly, and to maintain respiration.

### REFRIGERANT OIL

- **Eyes:** Immediately flush with large amounts of water for at least 15 minutes. Get prompt medical attention.
- **Skin:** Remove contaminated clothing. Wash thoroughly with soap and water. Get medical attention if irritation persists.
- **Inhalation:** Move victim to fresh air and use Cardio Pulmonary Resuscitation (CPR) or mouth-to-mouth resuscitation to restore breathing, if necessary. Stay with victim until emergency personnel arrive.
- **Ingestion:** Do not induce vomiting. Immediately contact local poison control center or physician.

#### **ENGINE COOLANT**

- **Eyes:** Immediately flush with large amounts of water for at least 15 minutes. Get prompt medical attention.
- **Skin:** Remove contaminated clothing. Wash thoroughly with soap and water. Get medical attention if irritation persists.
- **Ingestion:** Do not induce vomiting. Immediately contact local poison control center or physician.

#### **BATTERY ACID**

- **Eyes:** Immediately flush with large amounts of water for at least 15 minutes. Get prompt medical attention. Wash skin with soap and water.
- **Skin:** Immediately remove contaminated clothing. Wash skin with large volumes of water, for at least 15 minutes. Wash skin with soap and water. Do not apply fatty compounds. Seek immediate medical assistance.
- **Inhalation:** Provide fresh air. Rinse mouth and nose with water. Seek immediate medical assistance.
- **Ingestion:** If the injured person is fully conscious: make the person drink extensive amounts of milk. Do not induce vomiting. Take the injured person immediately to a hospital.

#### **ELECTRICAL SHOCK**

Take IMMEDIATE action after a person has received an electrical shock. Get quick medical assistance, if possible.

The source of the shock must be quickly stopped, by either shutting off the power or removing the victim. If the power cannot be shut off, the wire should be cut with a non-conductive tool, such as a wood-handle axe or thickly insulated cable cutters. Rescuers should wear insulated gloves and safety glasses, and avoid looking at wires being cut. The ensuing flash can cause burns and blindness.

## Safety Precautions

---

If the victim must be removed from a live circuit, pull the victim away with a non-conductive material. Use wood, rope, a belt or coat to pull or push the victim away from the current. **DO NOT TOUCH** the victim. You will receive a shock from current flowing through the victim's body. After separating the victim from power source, immediately check for signs of a pulse and respiration. If no pulse is present, start Cardio Pulmonary Resuscitation (CPR). If a pulse is present, respiration might be restored by using mouth-to-mouth resuscitation. Call for emergency medical assistance.

### ASPHYXIATION

Move victim to fresh air and use Cardio Pulmonary Resuscitation (CPR) or mouth-to-mouth resuscitation to restore breathing, if necessary. Stay with victim until emergency personnel arrive.

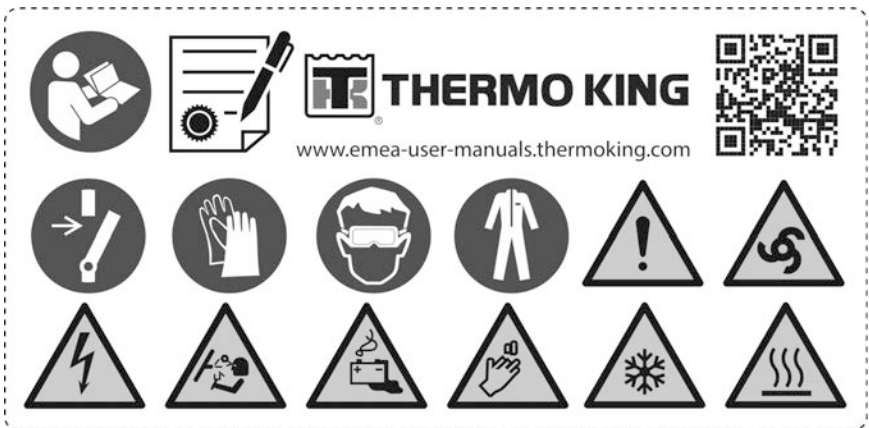
## Safety Decals

### Service

The Service decal is located in an appropriate location internally. This decal gives you the information to access/download your unit operator manual, but also the safety icons associated with your unit. These safety icons are directly associated with the information within this chapter. You can see the explanations for these icons starting from the beginning of this chapter.

**Note:** This decal only contains symbols of warning for the service of the unit.

**Figure 1. Service Decal**



BEN896

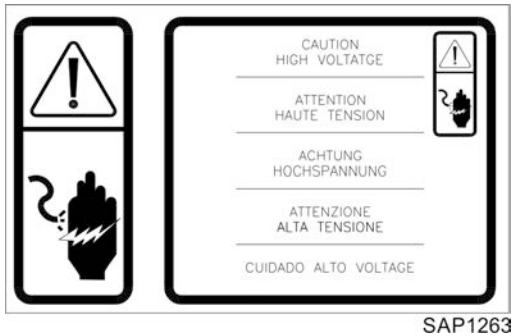
## Operation

The Operation decal is located in an appropriate position near your in-cab controller (HMI). This decal gives you the information to access/download your unit operator manual and other supporting documentation and in many supported languages.

**Figure 2. Operation Decal**



## High Voltage



- In the control box.



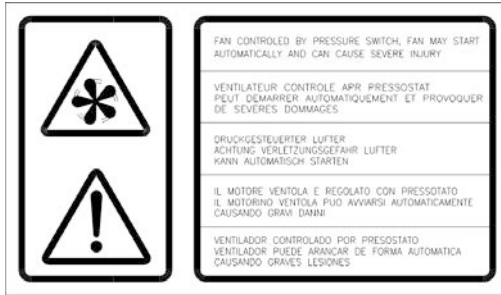
## Condenser and Evaporator Fans

Be aware of the warning nameplates ( ) in the following locations:

- On belt guard

- On rear of evaporator housing

**Figure 3. Fan Warning**



BEN580

## Remote Start of the Unit

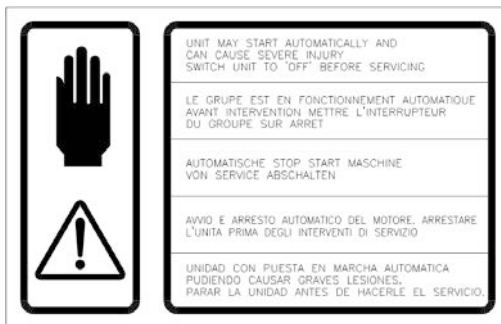
### ⚠ CAUTION

#### Risk of Injury!

The unit can start and run automatically any time the unit is turned on. Turn the unit On/Off switch Off before doing inspections or working on any part of the unit. Please note that only Qualified and Certified personnel should attempt to service your Thermo King unit.

Decals located behind service door.

**Figure 4. Unit Auto-start Warning**



BEN581



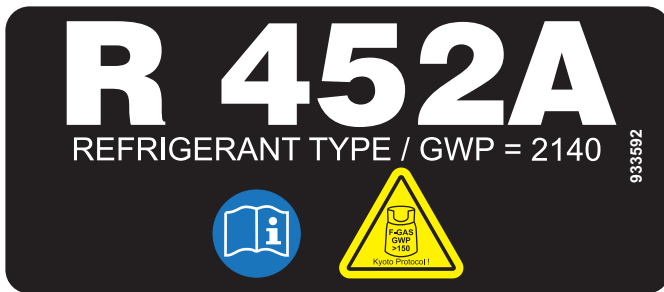
## Refrigerant

Refrigerant Decal is located adjacent to the service ports for charging or recovering the gas, as per the F-Gas regulation.



BEN178

Refrigerant Decal is located adjacent to the service ports for charging or recovering the gas.



RCS1686

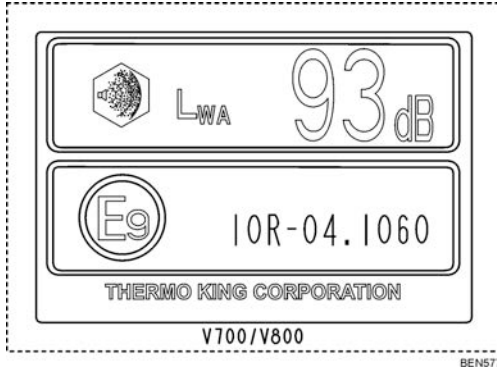
F Gas decal indicates that this equipment Contains fluorinated greenhouse gases.



SAP1243

## Type Certification

UNECE R10 decal sample.



# Unit Description

Thermo King Vehicle Powered Truck Units are two-piece units comprised of a condenser and evaporator designed for fresh, frozen, and deep frozen applications on small trucks and vans.

A belt driven compressor running off the vehicle's engine operates the refrigeration system during mobile operation. Electric Standby models have a second compressor located inside the condenser. This compressor is belt driven off an electric motor when connected to an AC power source during stationary operation.

The user friendly Direct Smart Reefer (DSR) controller makes operating your unit simple, while its modular design allows for ease of service.

V-Series Units Include:

- **V-100, V-200, V-300, V-500, V-600, V-800, V-1000:** for fresh temperature applications above 0°C.
- **V-100, V-200, V-300, V-500, V-600, V-800, V-1000 MAX:** for frozen temperature applications below 0°C and down to -32°C.

There are five basic models :

- **Model 10:** Cool and Defrost with only vehicle powered engine driven compressor operation.
- **Model 20:** Cool and Defrost with both vehicle powered engine driven compressor operation and electric standby compressor operation.
- **Model 30:** Hot gas heat, Cool, and Defrost with only vehicle powered engine driven compressor operation.
- **Model 50:** Hot gas heat, Cool and Defrost with both vehicle powered engine driven compressor operation and electric standby compressor operation.
- **Spectrum:** Multi-Temperature versions of the models above with the cargo area split into zones of different temperature combination settings.

Two add-on heat options are available:

- Coolant Heat (Models 10 and 20 only).
- Coolant and Electric Heat (Model 20 only).

## Unit Description

---

### Standard Unit Features

- **Condenser** - Lightweight design, easy to service with automotive grade polypropylene cover.
- **Evaporator** - Ultra slim design, aluminum construction automotive grade Acrylonitrile Butadiene Styrene (**ABS**) cover.
- **Controls** - User friendly Direct Smart Reefer (DSR) In-Cab controller.
- **Refrigerant** - R-134a, R-452A or R-404A (depending on unit model).

### Options

- Electric Standby
- Hot Gas, Electric or Coolant Heating
- Door Switch Kit
- Discharge Muffler Kit
- Snow Covers
- Refrigeration Hose / Harness Covers
- Roof Top Mounting Kit
- TracKing®
- Electric Standby Plug (115 Vac, 230 Vac 1phase NOT in V800/V1000, 230 Vac 3 phase, 400 Vac 3 phase)

**Note:** Some options are available factory installed or as a retrofit option to suit individual customer needs.

### System Components

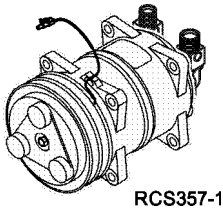
The system consists of the following main components:

#### Compressor(s)

All V-Series systems utilize an engine driven compressor and a swash plate or reciprocating compressor depending on model. Electric standby models also have an electric motor that operates a second compressor located inside the condenser.

All V-Series systems utilize an engine driven compressor and a swash plate compressor. Electric standby models also have an electric motor that operates a second compressor located inside the condenser.

**Figure 5. Swash Plate Compressor**



RCS357-1

**Condenser**

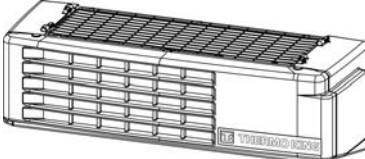
The condenser is located on the roof of the vehicle or on the front of the cargo box. The cover can easily be removed to access the fuses or service the unit.

**Figure 6. Condensers, V-Series**

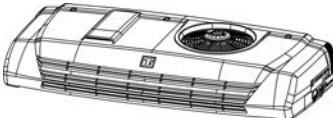
V-100 10/30



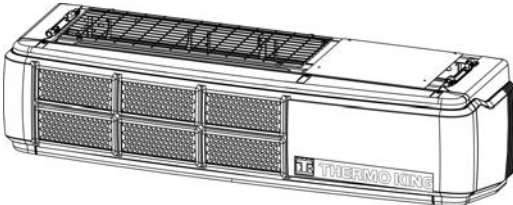
V500 V600 10/30/20/50 SERIES, V500 MAX30/50 SPECTRUM



V200/V300 20/50



V800/V1000 10/20 SINGLE TEMP., 30/50 SINGLE TEMP., 30/50 SPECTRUM



V200/V300 SPECTRUM 20/50



BEE967

**Evaporator**

The evaporator is mounted on the ceiling inside the cargo box. The cover can easily be removed for service.

# THERMO KING

## Unit Description

---

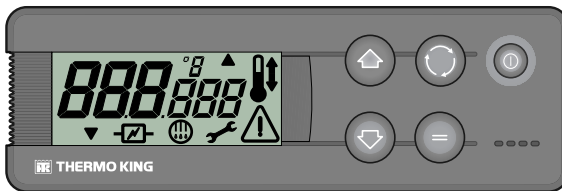
**Figure 7. Evaporator**



## Electronic Control System

The Electronic Control System is composed of an Electronic Control Module (located inside the condenser unit), an interface Board Module, and the HMI. This HMI allows the truck driver to operate the Thermo King refrigeration unit.

**Figure 8. HMI**



BEN229

## Description

The Electronic Control System has the following characteristics:

- Auto Start
- Soft Start
- Active Display
- Lit Keypad
- Total Hourmeter
- Vehicle Compressor Hourmeter
- Electric Standby Compressor Hourmeter
- Low Battery Voltage Alarm

- Buzzer
- Unit Control without HMI
- Manual or Automatic Defrost
- Maintenance Warning
- Return Air Temperature Sensor
- Setpoint Temperature Reading
- Electric Power Warning
- Independent connection/disconnection of compartments in multi-temperature units

**Auto Start:** Should the unit stop due to a failure in the power supply, whether during on-the-road or electric standby operation, it will start up again as soon as the power supply is re-established.

**Soft Start:** All operation modes remain inactive for a few seconds after an Auto Start.

**Active Display:** The HMI display is always active and backlit except when the unit is disconnected (no power) or when the unit is connected but has been manually switched off from the HMI (when there is no active alarm).

**Lit Keypad:** The HMI keys are always lit except when the unit is disconnected (no power) or when the unit is connected but has been manually switched off from the HMI (when there is no active alarm). The On/Off key is always lit except when the unit is disconnected (no power), and thus indicates the presence of power in the unit.

**Total Hourmeter:** Total number of hours the unit is in operation.

**Vehicle Compressor Hourmeter:** Compressor hours in road mode.

**Electric Standby Compressor Hourmeter:** Compressor hours in electrical standby mode.

**Low Battery Voltage Alarm:** Disconnects the unit when the battery voltage falls below 10.5V in 12VDC systems or below 21V in 24VDC systems.

**Buzzer:** It is energised when the vehicle battery and the electric power supply are connected at the same time. It is also energised if the doors are opened while the refrigeration unit is running.

**Unit Control without HMI:** The unit can also be operated by the Electronic Control System without the HMI, under conditions selected by the HMI before it is disconnected.

**Manual or Automatic Defrost:** It is possible to choose between manual or automatic defrost.

## Unit Description

**Maintenance Warning:** On-screen warning of the need to carry out maintenance on the unit.

**Return Air Temperature Sensor:** On-screen reading of the temperature in the load compartment. In bi-temperature units, the temperature in both compartments can be read on the same screen.

**Setpoint Temperature Reading:** On-Screen Setpoint Temperature Reading. In bi-temperature units, the setpoint temperature of both compartments can be read on the same screen.

**Electric Power Warning:** On-screen warning that the unit is connected to an electric power supply.

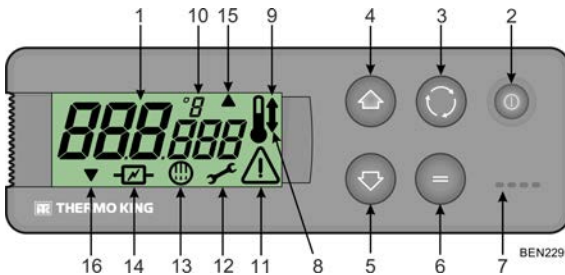
## Unit Controls

**⚠ WARNING**

**Risk of Injury!**

Never operate the unit unless you completely understand the controls; otherwise serious injury may occur.

**Figure 9. In-cab Control Panel (HMI) Display, Keys, Symbols**



1. Display	It is always active and backlit except when the unit is disconnected (no power) or when the unit is connected but has been manually switched off from the HMI. It normally displays the return air temperature (of both load compartments in multi-temperature units).
2. On/Off Key	This key is used to start/stop the unit. It is always lit except when the unit is disconnected (no power), and thus acts as an indicator of the presence of power in the unit.
3. Select Key	Selects prompt screens and information screens.
4. Up Key	Is used to increase the setpoint temperature.



5. Down Key	Is used to reduce the setpoint temperature.
6. Enter Key	Is used to enter a new command such as manual defrost, etc.
7. Buzzer	It is energised when the vehicle battery and the electric power supply are connected simultaneously. It is also energized if the doors are opened while the refrigeration unit is running.
8. Cool Symbol	(Thermometer with an arrow pointing downward). The unit is cooling.
9. Heat Symbol	(Thermometer with an arrow pointing upward). The unit is heating.
10. °C/°F Symbol	Indicates whether the on-screen temperature reading is in degrees Celsius (C) or degrees Fahrenheit (F).
11. Alarm Symbol	Indicates that there is an alarm in the system.
12. Maintenance Symbol	Warns of the need to carry out maintenance to the unit.
13. Defrost Symbol	Indicates the unit is in Defrost Mode.
14. Electrical Symbol	Indicates that the unit is in Electric Standby.
15. Condenser Defrost Symbol	Indicates the condenser unit is in defrost mode (turns on at the same time as defrost symbol 13).
16. Combined Compartment Symbol	Indicates that the multi-temperature unit is working as a single temperature unit.

## Standby Operation (Models 20 and 50 Only)

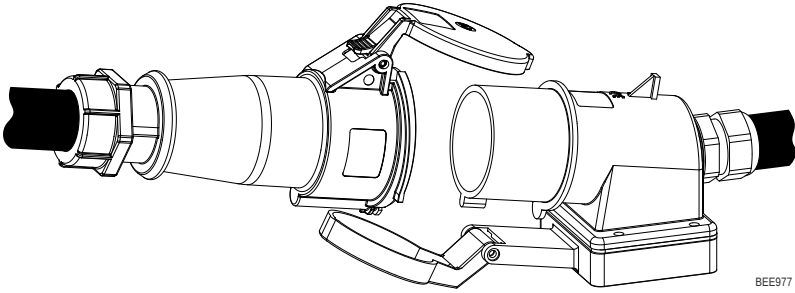
### **WARNING**

#### **Hazardous Voltage!**

A certified electrician should verify that the proper standby power requirements are being supplied before connecting to a new power source.

These units may be operated in electric standby mode by connecting the proper voltage power cable to the unit's power receptacle mounted on the vehicle. Standby operation is used while the vehicle is stationary with the engine shut off.

**Figure 10. Standby Power Receptacle**



## Electrical System

The unit's controls and refrigeration components operate on 12 Vdc or 24 Vdc (must match the voltage of the vehicle alternator)

Electric Standby units have a standby motor that operates on 230 Vac, 400 Vac 3 ph when connected to a remote power source. A transformer in the condenser unit converts the (NOT 115 V) 230 Vac 1 ph or 400 Vac 1 ph to 12 or 24 Vdc to operate the unit's controls and refrigeration components.

## Fuses

The electrical components are protected by various fuses.

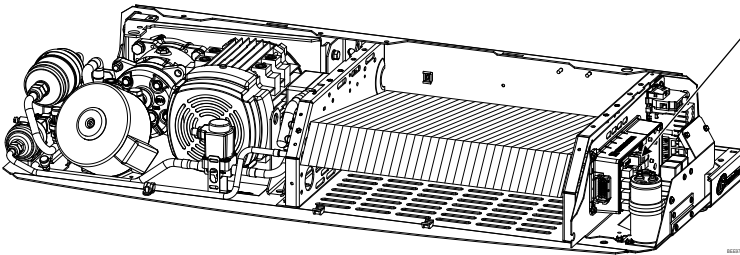
**Main Power Fuse** - The main power fuse is located in the vehicle's engine compartment and is connected directly to the vehicle's battery.

This in-line fuse is non-serviceable and must only be replaced by an authorized Thermo King Dealer.

**Ignition Power Fuse** - The ignition power fuse is connected to the vehicle's fused ignition system. Depending on the vehicle, the location of the fuse panel could be located inside the cab or under the hood of the vehicle.

**Unit Component Fuses** - These fuses are located in the condenser unit. Remove the condenser cover to access them. Depending on your model, some fuses may not be used. Refer to ("[Electrical Control System](#)," p. 53).

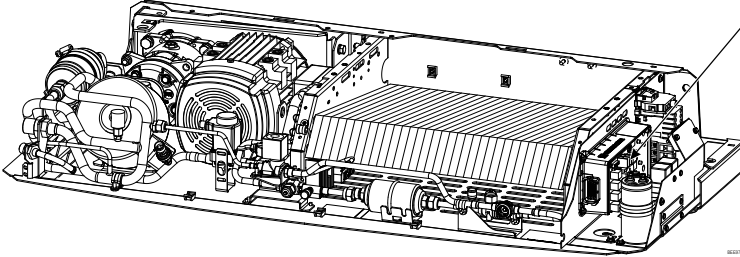
**Figure 11. V-200 V-300 Condenser, Fuses Location**



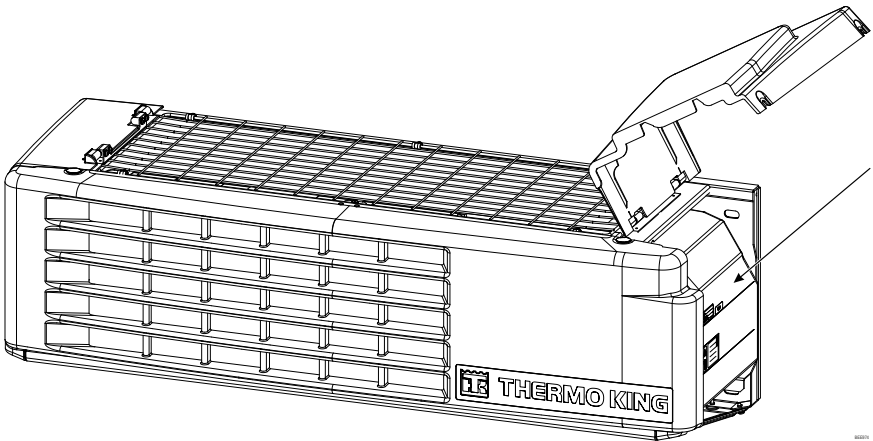
**THERMO KING**  
Unit Description

---

**Figure 12. V-200 V-300 SPECTRUM Condenser, Fuses Location**

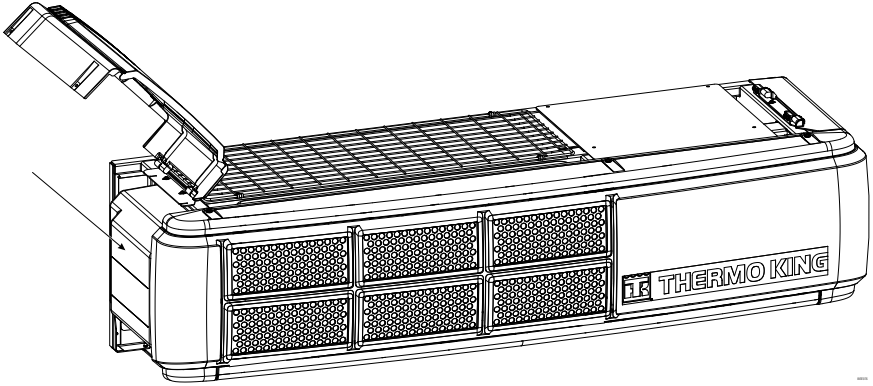


**Figure 13. V-500 V-600 Condenser, Fuses Location**



**Note:** Remove the cover to access the fuses.

**Figure 14. V-800 V-1000 Condenser, Fuses Location**



**Note:** Remove the cover to access the fuses.

## Unit Description

### Pharma

Single and Multi-temperatures temperature Units qualified for pharmaceutical applications under Thermo King protocol are configured with specific Pharma configuration file and parameters loaded during commissioning by your local dealer. Evaporators fans have to run during the Null Cycle.

ThermoKing recommends to run the unit with the recommended Setpoints below:

**Table 1. V-300 MAX Spectrum 30/50 ES150+ES150:**

<b>Temperature Range</b>	<b>Extreme Ambient Temperature</b>	<b>Recommended Setpoint</b>	<b>Max Deviation Setpoint</b>
Temperature between +2°C and +8°C	+40°C / -30°C	+6°C	+/- 2°C of setpoint
Temperature between +15°C and +25°C	+40°C / -30°C	+20°C	+/- 2°C of setpoint

**Table 2. V-500 MAX Spectrum 30/50 ES300+ES300:**

<b>Temperature Range</b>	<b>Extreme Ambient Temperature</b>	<b>Recommended Setpoint</b>	<b>Max Deviation Setpoint</b>
Temperature between +2°C and +8°C	+40°C / -30°C	+6°C	+/- 2°C of setpoint
Temperature between +15°C and +25°C	+40°C / -30°C	+20°C	+2/- 3°C of setpoint

**Table 3. V-800 MAX Spectrum 30/50 ES400+ES400:**

<b>Temperature Range</b>	<b>Extreme Ambient Temperature</b>	<b>Recommended Setpoint</b>	<b>Max Deviation Setpoint</b>
Temperature between +2°C and +8°C	+40°C / -30°C	+6°C	+3/- 2°C of setpoint
Temperature between +15°C and +25°C	+40°C / -30°C	+20°C	+/- 2°C of setpoint

**Table 4. V-300 MAX Spectrum 30/50 ES200+ES100:**

<b>Temperature Range</b>	<b>Extreme Ambient Temperature</b>	<b>Recommended Setpoint</b>	<b>Max Deviation Setpoint</b>
Temperature between +2°C and +8°C	-35°C	+4°C	+3/- 1°C of setpoint
	-20°C	+5°C	- 2°C of setpoint
Temperature between +15°C and +25°C	+35°C	+20°C	+/- 2°C of setpoint
	-20°C	+21°C	- 3°C of setpoint

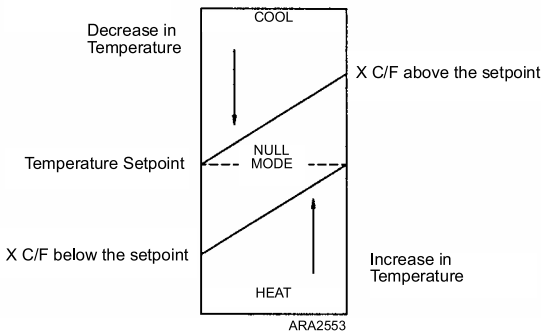
Efficient loading practices and operating procedures have to be followed to ensure optimum air circulation and temperature management.

# Operating Instructions

## General Operation

In truck-driven units, temperature control is based on two values: The setting (Setpoint) of the electronic thermostat and the evaporator return temperature. The difference between these two temperatures will determine the mode of operation: cool, heat, or null.

- **Cool:** When the temperature in the load compartment is higher than the setpoint, the unit runs in cool mode to reduce the evaporator return temperature.
- **Heat:** When the temperature in the load compartment is lower than the setpoint, the unit changes to heat mode to raise the evaporator return temperature.
- **Null:** Once the Setpoint Temperature has been reached, and while the temperature remains between X°C/F above or below the setpoint, there is no demand for transfer of heat or cold, and the unit runs in null mode.
- **Defrost:** After a scheduled period of time in cool mode, between 1 and 8 hours, the unit runs in this fourth mode of operation to eliminate ice that has accumulated in the evaporator or condenser coil. Defrost can be initiated automatically or manually.



Factory setting for X is 3°C (5°F). During unit installation, this value can be adjusted by between 1 and 5°C (2 and 9°F) in increments of 1°C/F.

**Units with R-134a refrigerant:** Units Recommended for Fresh Cargo applications. Temperatures can be controlled from -20°C to +22°C (-4°F to +71°F).



**Units with R-404A /R-452A refrigerant:** Temperatures can be controlled from -20°C to +22°C (-26°F to +71°F).



Address:  
Sant Josep, 140-142 P.I. "El Pla",  
Sant Feliu de Llobregat,  
Barcelona, Spain.

**Year of manufacture:** Reference Serial Plate.

Installation and commissioning are to be carried out by an authorised Thermo King Dealer in accordance with Thermo King procedures and drawings. Exceptions to this with the written authorisation of the manufacturer only.

## Starting the Unit

### Engine Operation

1. Start the vehicle.
2. Press the On/Off Key located in the HMI. The HMI display will be activated.
3. Check the setpoint, and adjust if necessary.

### Electric Standby Operation

1. Connect the external power supply to the electric power receptacle. Verify the power supply is of the correct voltage and phase for the unit.

#### **⚠ WARNING**

##### **Hazardous Voltage!**

In case of outdoor conditions, ensure that the connection is made under safe conditions.

2. Press the On/Off Key located in the HMI. The HMI display will be activated. The electric symbol will appear on the screen.
3. Check the setpoint, and adjust if necessary.

**Notes:**

1. *Regular monitoring of the unit is recommended, the frequency of this monitoring will depend on the type of cargo.*
2. *The operating mode, whether engine-driven or electric standby, is selected automatically. When the unit is connected to an electric power source, engine-driven operation is automatically blocked. If the truck engine is started up while the power cable is still connected to the electrical power source, the unit will continue to operate in electric standby mode and the buzzer will be activated.*

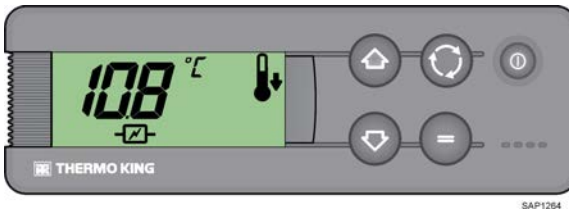
## Standard Display

This is the display that appears when the On/Off key is pressed and the unit started. It normally displays the return air temperature (of both load compartments in bi-temperature units) and the current operating mode with the appropriate symbol.

Should there be an alarm, the alarm symbol will also appear on screen.

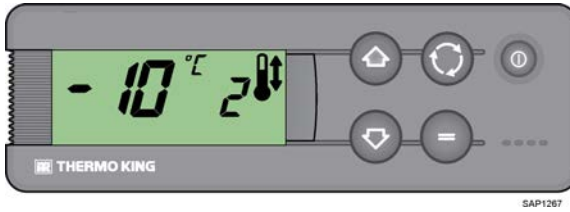
## Single Temperature Units

The example below shows 10.8°C temperature, cool mode, and standby operation.



## Multi-Temperature Units

The example below shows -10°C temperature and cool mode in the main compartment, and 2°C temperature and heat mode in the remote compartment. Unit running in on-the-road mode.



SAP1267

## Entering Setpoint Temperature

The Setpoint Temperature can be quickly and easily changed.

### Single Temperature Units

1. Press and release the Select key twice (three times for reverse cycle units), and the current Setpoint Temperature and the letters *SP* will appear on screen.



AFV31

2. Press the Up or Down arrow keys to select the desired Setpoint Temperature. Each time either of these buttons is pressed and released, the Setpoint Temperature will change one degree.
3. Press and release the Enter key to set the setpoint or press and release the Select key to set the setpoint and return to the Standard Display.

**Important:** *If the Select key or the Enter key is not pressed within 20 seconds to select the new Setpoint Temperature, the unit will continue to run at the original Setpoint Temperature.*

### Multi-Temperature Units

**Note:** *Since software MSK 544.03, Thermo King has introduced a Zone Priority function which allows Spectrum units to provide cooling or heating priority for a specific zone to satisfy setpoint as soon as possible. Contact your local dealer for detailed information.*

## Operating Instructions

---

1. **Main Load Compartment:** Press and release the SELECT key twice, and the current Setpoint Temperature in the main compartment and the letters **SP** will appear on screen.



AFV31

2. Press the UP or DOWN arrow keys to select the desired Setpoint Temperature. Each time either of these buttons is pressed and released, the Setpoint Temperature will change one degree.
3. Press and release the ENTER key to set the setpoint or press and release the SELECT key to set the setpoint and to change to the **Remote Compartment** Setpoint Temperature Setting Screen.

**Important:** If the Select key or the Enter key is not pressed within 20 seconds to select the new Setpoint Temperature, the unit will continue to run at the original Setpoint Temperature.

4. **Remote Load Compartment:** The present Setpoint Temperature in the remote compartment and the letters **SP2** will appear on screen.



AFV32

5. Press the UP or DOWN arrow keys to select the desired Setpoint Temperature. Each time either of these buttons is pressed and released, the Setpoint Temperature will change one degree.
6. Press and release the Enter key to set the set point value or press and release the SELECTION key to set the set point and move to the **CSE (Compartment Selection)** screen.

**Important:** If the Select key or the Enter key is not pressed within 20 seconds to select the new Setpoint Temperature, the unit will continue to run at the original Setpoint Temperature.

## Compartment Selection

1. Press the key UP or DOWN to change option between the four different options available:
  - **1-2:** This is the standard multi-temperature setting where both compartments (zones) are active.



ASA978

- The screen shows the temperature in both compartments (zones).



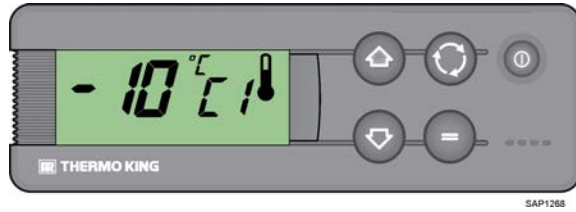
SAP1267

- **C1:** Compartment 1 is active while Compartment 2 is disabled.



ASA979

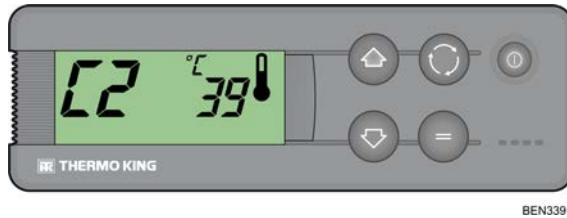
- Only the temperature for compartment 1 appears on the screen, while no reading is shown for compartment 2.

**Operating Instructions**

- **C2:** Compartment 2 is active while Compartment 1 is disabled.



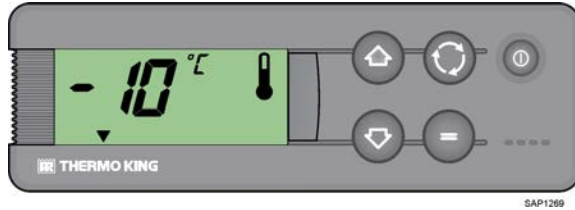
- Only the temperature for compartment 2 appears on the screen, while no reading is shown for compartment 1.



- **1-1:** Compartments 1 and 2 are combined to operate as a single-temperature unit; only the temperature for Compartment 1 is displayed.



- The screen shown as that of a single-temperature unit but with the triangle symbol activated to indicate that it is actually a bi-temperature unit operating as a single-temperature unit.



2. Press and release the ENTER key to select an option or press and release the SELECTION key to select an option and return to the standard screen.

**Important:** *If the Select key or the Enter key is not pressed within 20 seconds to select the new Setpoint Temperature, the unit will continue to run at the original Setpoint Temperature.*

## Initiating the Evaporator Manual Defrost Cycle

**Important:** *Before initiating a manual defrost, ensure that the unit is not already in a defrost cycle. When the unit is in a defrost cycle the defrost symbol appears on screen.*

1. Press and release the Select key once, and the letters *dEF* will appear (flashing) on screen along with the present defrost condition *OFF*.

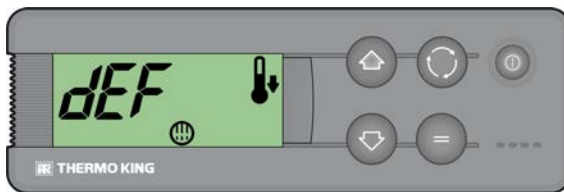


2. To activate manual defrost, press the Enter key and then the Up or Down key and the defrost condition will change to *On*.



RCS372

3. Press the Select key twice to return to the Standard Display (three times in bi-temperature units and in reverse cycle units), where the letters *dEF* and the DEFROST symbol will appear when the defrost cycle starts (the load compartment temperature must be lower than 0°C).



BEN241

**Note:** The letters *dEF* will remain on screen for a while after returning to cool mode.

## Initiating the Condenser Manual Defrost Cycle (reverse cycle units only)

**Important:** Before initiating a manual defrost, ensure that the unit is not already in a defrost cycle. When the unit is in a defrost cycle the defrost symbol appears on screen.

1. Press and release the Select key twice, and the letters *dFC* will appear (flashing) on screen along with the present defrost condition *OFF*.



BEN242

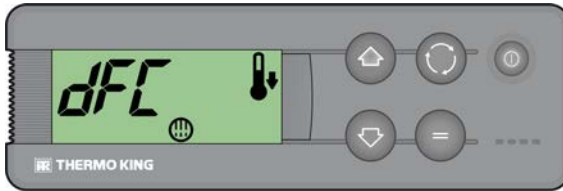


2. To activate manual defrost, press the Enter key and then the Up or Down key and the defrost condition will change to *On*.



BEN243

3. Press the Select key twice to return to the Standard Display where the letters *dFC* and the DEFROST symbol will appear when the defrost cycle starts (the outside ambient temperature must be lower than 0°C).



BEN244

## Alarms

When the unit is not operating properly, the microprocessor records the alarm code, alerts the operator by displaying the Alarm symbol and, depending on the type of alarm, shuts the unit down.

There are three alarm categories:

### Manual Start

The alarm stops the unit, and only the Alarm symbol appears on screen.



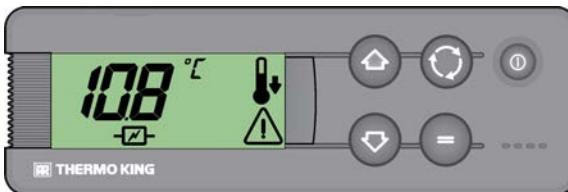
RCS370

Once the alarm condition has been rectified, the On/Off key must be pressed to start up again.

Press and release the Select key to display the current alarm code on screen. If there is more than one active alarm, all the alarm codes on the unit can be viewed in sequence by pressing and releasing the Select key.

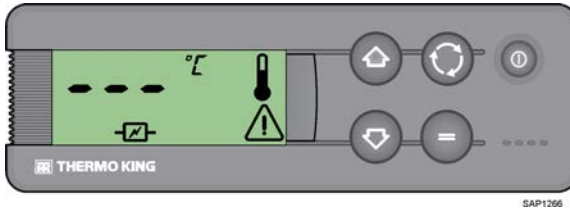
### Auto Start

The alarm stops the unit, the Alarm symbol appears on screen and the unit starts up automatically once the alarm condition has been rectified.



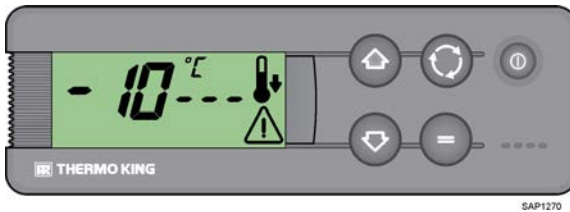
SAP1265

Should a **P1E** alarm occur (return air temperature read error alarm code) appear, — will appear on screen together with the alarm symbol, instead of the return air temperature reading.



If it is a multi-temperature unit, the — will appear on the screen together with the alarm symbol, instead of the main compartment return air temperature reading.

In multi-temperature units, should a P2E - return air temperature read error in the remote compartment alarm code - appear, — will also appear on screen together with the alarm symbol, instead of the remote compartment return air temperature reading.



Press and release the Select key to display the current alarm code on screen. If there is more than one active alarm, all the alarm codes on the unit can be viewed in sequence by pressing and releasing the Select key.

## Buzzers

The buzzers are energized when the vehicle battery and the electrical supply are connected simultaneously (the unit continues running in Standby mode). The buzzers are also energized if the doors open, if this option is selected.

## Alarm Code Descriptions

**Table 5. Color Code Definitions**

OK TO RUN	CHECK AS SPECIFIED	TAKE IMMEDIATE ACTION
<b>Alarm</b>		
<b>Description</b>		
<b>Manual Start</b>		
OL		<p><b>Electric Motor Overload (Electric standby models only)</b> - The electric motor overload relay has tripped due to excessive current draw.</p> <p><i>If the problem persists when the unit is restarted, contact your Thermo King Dealer.</i></p>
bAt		<p><b>Low Battery Voltage</b> - Check vehicle battery.</p>
<b>Auto Start</b>		
HP		<p><b>High Pressure Alarm</b> - The system has detected excessively high discharge pressure.</p> <p><i>If the problem persists when the unit is restarted, contact your Thermo King Dealer.</i></p>
LP		<p><b>Low pressure alarm</b> - The system has detected excessively low suction pressure and has protected the compressor from an abnormal condition. Unit operation will resume automatically once the normal suction pressure is restored, and the alarm can be cleared (see "Clearing Alarm Codes," p. 49).</p> <p>Among other reasons, this could be due to:</p> <ul style="list-style-type: none"> <li>• Dirty evaporator coil – excessive ice formation.</li> <li>• Load stacked in front of the evaporator does not allow proper air recirculation through the box.</li> </ul> <p><i>If the problem persists when the unit is restarted, contact your Thermo King dealer.</i></p>
PSE		<p><b>High Pressure Sensor Failure</b> - The high pressure sensor has become faulty or disconnected.</p> <p><i>Contact your Thermo King Dealer.</i></p>
dr1, dr2		<p><b>Cargo Doors Are Open (Units with door switch option only)</b> - Check if the Doors are open. if not, then the door switches are faulty, or improper door switch configuration.</p> <p><i>Contact your Thermo King Dealer.</i></p>
tCO		<p><b>Control Module Overheating</b></p> <p><i>If the problem persists when the unit is restarted, contact your Thermo King Dealer.</i></p>
SOF		<p><b>Software Failure</b></p> <p><i>Contact your Thermo King Dealer.</i></p>

Alarm	Description
P1E	<b>Faulty Cargo Box Return Air Temperature Sensor</b> - Faulty or disconnected return air temperature sensor. <i>Contact your Thermo King Dealer.</i>
P2E	<b>Remote Cargo Box Return Air Temperature Reading Error (open circuit or short-circuit)</b> <i>Contact your Thermo King Dealer.</i>
C	<b>Communications Failure</b> <i>Contact your Thermo King Dealer.</i>
H03	<b>SCM communication lost</b> - Communication lost to Smart Charger Module. <i>If the problem persists when the unit is restarted, contact your Thermo King Dealer.</i>

## Clearing Alarm Codes

The alarm condition in the unit must first be corrected. See important note below. After resolving the alarm condition, press and release the Select key to remove existing Alarm codes. The Standard Display will appear once the Alarm codes have been cleared.

### To Clear Alarm Codes:

- Correct the cause of the alarm code.
- Press the Select key to remove the alarm code.
- If more than one alarm code is present, press the Select key to clear each alarm code individually.

**Important:** *Continually clearing alarm codes without resolving the problem will result in damage to the unit and compressor.*

**Notes:** *The bAt alarm is the unique DSR-III alarm that requires manual confirmation. The DSR-III will keep in OFF condition until the operator acknowledges and the voltage is above the BCH value(factory setting 10.5v).*

### **The way to acknowledge this alarm is as follows:**

1. *Press the Select key once to show the Alarm screen. You will now see the bAt Alarm code.*
2. *Press the Select key again to acknowledge the alarm, and Press the select key again and again until the screen returns to the standard Display.*

## Viewing Information Screens

### Main Menu

From the Standard Display use the Select key to display:

1. Alarms (if any active).
2. Evaporator Manual Defrost.
3. Condenser Manual Defrost (reverse cycle units only).
4. Temperature Setpoint.

### Hourmeter Menu

From the Standard Display press the Select key for three seconds to open the Hourmeter Menu, then use the Select key to display:

**Note:** For units with firmware version 380.03 and earlier: The unit of measurement is tens of hours (e.g., 150 = 1500 hours). For units with firmware version 380.06 and later: The unit of measurement is hours.

1. **HC:** Hours remaining to maintenance notice.
2. **tH:** The total amount of time the unit has been switched on protecting the load.
3. **CC:** Engine driven compressor operating hours.
4. **EC:** Electric standby compressor operating hours.
5. Return to Main Menu.

# Loading and Inspection Procedures

This chapter describes pre-loading inspections, loading procedures, post-loading procedures, post-loading inspections, and enroute inspections. Thermo King refrigeration units are designed to maintain the required product load temperature during transit. Follow these recommended loading and enroute procedures to help minimize temperature related problems.

## Post-Start Inspection

**Thermostat:** Adjust the thermostat setting to above and below the compartment temperature to check thermostat operation (see Operating Modes).

**Pre-cooling:** With the thermostat set at the desired temperature, run the unit for half-an-hour to one hour (or longer if possible) before loading the truck. Pre-cooling eliminates residual heat and acts as a good test of the refrigeration system.

**Defrost:** When the unit has finished pre-cooling the truck interior - the evaporator temperature should have dropped below 2°C (35.6°F) - initiate a defrost cycle with the manual defrost switch. The defrost cycle should stop automatically.

## Loading Procedure

1. To minimise frost accumulation in the evaporator coil and a heat increase inside the load compartment, ensure that the unit is OFF before opening the doors (The unit may continue to run when the truck is being loaded in a warehouse with the doors closed).
2. Carefully check and record the load temperature when loading the truck. Note whether any products are out of temperature range.
3. Load the product in such a way that there is sufficient space for the air to circulate throughout the load. DO NOT block the evaporator inlet or outlet.
4. Product should be pre-cooled before loading. Thermo King units are designed to maintain the load at the temperature at which it is loaded. Transport refrigeration units are not designed to reduce the load temperature.

## Post Load Procedure

1. Verify all doors are closed and locked.

## Loading and Inspection Procedures

---

2. Adjust the thermostat to the desired temperature setpoint.
3. Start the unit.
4. Half an hour after loading the truck, defrost the unit for a moment by pressing the Manual Defrost switch. If the coil temperature drops to below 2°C (35.6°F), the unit will defrost. The defrost cycle should stop automatically.



# Specifications

## Refrigeration System

Contact your Thermo King dealer for refrigeration system service or maintenance.

## Compressor

	<b>V-100/ V-200s</b>	<b>V-200</b>	<b>V-300</b>	<b>V-500/ V-600</b>	<b>V-800</b>	<b>V-1000</b>
Compressor Model	TK08N	QP13	QP15	QP16	QP21	QP25
Displacement (cc)	82	131	146.7	163	215	249
Number of cylinders	6	6	6	6	10	10

## Electrical Control System

	<b>12 Vdc</b>	<b>24 Vdc</b>
<b>Fuses</b>		
<b>Common Fuses</b>		
Fuse 3: Evaporator Fan Motor (EFM1)	15 amps	10 amps
Fuse 4: Evaporator Fan Motor (EFM2)	15 amps	10 amps
Fuse 5: Roadside (Engine) Compressor Clutch (CCL1), Liquid Injection Switch (LIS), Liquid Injection Valve (LIV), EVAP1 Defrost Hot Gas Solenoid Valve (PS1), Compressor Motor Contactor (CMC), Heat Pilot Solenoid (PS5)	20 amps	10 amps
Fuse 14: Vehicle Ignition Switch	5 amps	5 amps
Fuse 30: Condenser Fan Motor (CFM) (located in CF1 wire near terminal strip in condenser section)	16 amps	10 amps
<b>V-100/V-200s</b>		
Fuse 6: Condenser Fan 1/2	2 amps	2 amps
Fuse 21: Battery Power Supply (located in 2 wire near battery)	30 amps	30 amps

## Specifications

<b>V-200/V-300 and Spectrum</b>		
Fuse 6: Condenser Fan 1/2	2 amps	2 amps
Fuse 8: (Spectrum Only) EVAP2 Liquid Solenoid Valve (PS2), EVAP1 Liquid Solenoid Valve (PS3), EVAP2 Defrost Hot Gas Solenoid Valve (PS4), Drain Heaters 3 and 4 (HT3, HT4)	20 amps	10 amps
Fuse 9: (Spectrum Only) Evaporator Fan 3	15 amps	10 amps
Fuse 10: (Spectrum Only) Evaporator Fan 4	15 amps	10 amps
Fuse 11: Drain Heaters (H1 and H2)	2 amps	2 amps
Fuse 20: Transformer AC Power Supply (located at compressor motor contactor in condenser section)	4 amps	4 amps
Fuse 21: Battery Power Supply (located in 2 wire near battery)	40 amps	40 amps
<b>V-500/V-600 and Spectrum</b>		
Fuse 6: Condenser Fan 1/2	10 amps	7.5 amps
Fuse 8: (Spectrum Only) EVAP2 Liquid Solenoid Valve (PS2), EVAP1 Liquid Solenoid Valve (PS3), EVAP2 Defrost Hot Gas Solenoid Valve (PS4), Drain Heaters 3 and 4 (HT3, HT4)	20 amps	10 amps
Fuse 9: (Spectrum Only) Evaporator Fan 3	15 amps	10 amps
Fuse 10: (Spectrum Only) Evaporator Fan 4	15 amps	10 amps
Fuse 11: Drain Heaters (H1 and H2)	2 amps	2 amps
Fuse 17: Drain Heaters (H3 and H4)	2 amps	2 amps
Fuse 20: Transformer AC Power Supply (located at compressor motor contactor in condenser section)	4 amps	4 amps
Fuse 21: Battery Power Supply (located in 2 wire near battery)	50 amps (Single Temp)	60 amps (Multi-Temp)
Fuse 31: Condenser Fan Motor 2 (CFM2) (located in CF2 wire near terminal strip in condenser section)	16 amps	10 amps

<b>V-800, V1000 and Spectrum</b>		
Fuse 1: Condenser Fan Motor (CFM1)	15 amps	10 amps
Fuse 2: Condenser Fan Motor (CFM2)	15 amps	10 amps
Fuse 3: Evaporator Fan 1	15 amps	10 amps
Fuse 4: Evaporator Fan 2	15 amps	10 amps
Fuse 5: PS1, PS7, CMC, LIV,PS5, RCV, CCL	20 amps	10 amps
Fuse 10: (Spectrum Only) Evaporator Fan 4	15 amps	10 amps*
Fuse 6: Drain Heaters 1/2	2 amps	2 amps
Fuse 8: (Spectrum Only) EVAP2 Liquid Solenoid Valve (PS2), EVAP1 Liquid Solenoid Valve (PS3), EVAP2 Defrost Hot Gas Solenoid Valve (PS4), Drain Heaters 3 and 4 (HT3, HT4)	20 amps	10 amps
Fuse 9: (Spectrum Only) Evaporator Fan 3	15 amps	10 amps
Fuse 10: (Spectrum Only) Evaporator Fan 4	15 amps	10 amps*
Fuse 11: Drain Heaters (H3 and H4)	2 amps	2 amps
Fuse 14: Ignition	5 amps	5 amps
Fuse 17: TrackKing	5 amps	5 amps
Fuse 20: Transformer AC Power Supply	5 amps (time delay fuse)	5 amps (time delay fuse)
Fuse 21: Battery Power Supply (located in 2 wire near battery)	1000 amps	60 amps
Fuse 41: Evaporator Fan 5	11 amps	10 amps
Fuse 41: Evaporator Fan 6	11 amps	10 amps

**Note:** \* 15 A in Spectrum Versions with Double Evaporator Fan 4

<b>Condenser Fan Motor (All except V-800/V-1000)</b>		
Voltage	13 Vdc	26 Vdc
Full Load Current	10 Amps	4.7 Amps
Power Rating	130 W	122 W
RPM with Full Load	2,800	2,800

## Specifications

<b>Condenser Fan Motor (V-800/V-1000)</b>		
Voltage	9–15 Vdc	16–32 Vdc
Full Load Current	11 Amps	10 Amps
Power Rating	145 W	240 W
Control Voltage Range	1–10 Vdc	6.5–10 Vdc

<b>Evaporator Fan Motors (All except ES-800/ES-1000)</b>		
Voltage	13 Vdc	26 Vdc
Full Load Current	7.5 Amps	4 Amps
Power Rating	97.5 W	104 W
RPM with Full Load	2,800	2,800

<b>Evaporator Fan Motors (ES-800/ES-1000)</b>		
Voltage	14 Vdc	28 Vdc
Full Load Current	5.7 Amps	3.4 Amps
RPM with Full Load	2,350	2,430
Speed control	0 to 10 Vdc	0 to 10 Vdc
Type	Brushless DC motor	Brushless DC motor

<b>Transformer (All except V-800/V-1000)</b>	
Power	500 VA
Frequency	50/60 Hz
Primary Inputs	115-208-230 Vac
Secondary Nominal Voltage	11.7 Vac (21.4 Amps)

<b>Transformer (V-800/V-1000)</b>	
Power	1100 VA

 **THERMO KING**  
**Specifications**

Frequency	50/60 Hz
Primary Inputs	230–400 Vac
Secondary Nominal Voltage	2 windings: 11.7 Vac (47 Amps) and 11.7 Vac (47 Amps)

## Specifications

### Electric Motor (Model 50)

#### AC Electric Compressor Motors and Overload Relays

Voltage/ Phase/ Frequency	Horse- power	Kilowatts	RPM	Full Load (amps)	Overload Relay Setting (amps)
<b>V-100/V-200s</b>					
230/1/50	2.0	1.5	1750	5.4	5.5
<b>V-200/V-300</b>					
230/1/50	2.0	1.5	1750	8.6	8.6
230/1/60	2.0	1.5	1750	9	9
230/3/60	2.4	1.8	1750	6.9	6.9
400/3/50	2.4	1.8	1750	4	4
400/3/60	2.4	1.8	1750	4	4
<b>V-500/V-600 (Semi hermetic Standby compressor)</b>					
115/1/60	1.5	1.1	1710	14	14
208/1/60	2.0	1.5	1740	9.5	9.5
230/1/60	2.0	1.5	1750	9	9
208/3/60	2.4	1.8	1730	7.2	7.2
230/3/60	2.4	1.8	1750	6.9	7
<b>V-800 (Semi hermetic Standby compressor)</b>					
230/3/50	3	2.3	1450	57/16.6 amps	18
400/3/50	3	2.3	1450	32.9/9.6 amps	14
230/3/60	3	2.3	1740	68.4/19.9 amps	18
400/3/60	3	2.3	1740	39.5/11.5 amps	14
<b>V-1000 (Semi hermetic Standby compressor)</b>					
230/3/50	5	3.7	1450	22/109 amps	24

<b>Voltage/ Phase/ Frequency</b>	<b>Horse- power</b>	<b>Kilowatts</b>	<b>RPM</b>	<b>Full Load (amps)</b>	<b>Overload Relay Setting (amps)</b>
400/3/50	5	3.7	1450	12.7/63.1 Amps	16
230/3/60	5	3.7	1740	26.5/121 Amps	24
400/3/60	5	3.7	1740	15.3/70.1 amps	16

## TracKing

Platform	ARM Cortex-A8, 300MHz, 256MB RAM, 4GB Flash, Linux
GSM/GPRS	3G, Sierra HL8548
GPS	u-blox NEO-7M
Bluetooth	Version 4.0 Bluetooth Classic /Bluetooth Low Energy (BLE)
Serial Ports	2 External Serial Ports for TracKing extensions or Third-Party Connect
Input Power	12V Nominal
Backup Battery	Single cell Li-Ion 3.7V Nominal, > 2Ah
Environmental Storage Temperature	-40 to +85 C

# Warranty

Please also refer to TK 61654-18-WA Thermo King EMEA Unit Limited Warranty for Vehicle Powered Truck Units.



# Inspection and Service Intervals

## Weekly Pre-Trip Checks

1. Visually inspect belt.
2. Listen for unusual noises, vibrations, etc.
3. Visually inspect unit for fluid leaks (coolant, oil, refrigerant).
4. Visually inspect unit for damaged, loose or broken parts (including air ducts and bulkheads, if so equipped).
5. In the event of excess of dirt or obstruction clean the unit, including condenser and evaporator coils.

## Weekly Pretrip Inspection

The following Weekly Pretrip Inspection should be completed before starting the unit and loading the truck. While the weekly inspection is not a substitute for regularly scheduled maintenance inspections, it is an important part of the preventive maintenance program designed to head off operating problems before they happen.

**Leaks:** Inspect for refrigerant leaks and worn refrigerant lines.

**Battery:** Terminals should be properly tightened and show no signs of corrosion.

**Belts:** Inspect for cracks, wear, and proper belt tension.

**Mounting Bolts:** Verify bolts are properly tightened.

**Electrical:** Electrical connections should be securely fastened. Wires and terminals should be free of corrosion, cracks, or moisture.

**Structural:** Visually check for physical damage.

**Coils:** The condenser and evaporator coils (evaporator coils in multi-temperature units) should be clean and free of debris.

**Coils:** The condenser and evaporator coils should be clean and free of debris.

- Washing with clean water should be sufficient. The use of cleaning agents or detergents is strongly discouraged due to the possibility of degradation of the construction. If using a power washer, the nozzle pressure should not exceed 600 psi (41 bar). For the best results, spray the coil perpendicular to the face of the coil. The spray nozzle should be kept between 1 inch and 3 inches (25 to 75 millimeters) from the coil surface.

## Inspection and Service Intervals

---

**Important:** *Models V-500 and V-800/V-1000 feature a high efficient micro channel aluminum condenser coil, in these cases the spray nozzle should be kept 300mm away from the coil and aimed perpendicularly to the coil surface to avoid damaging the aluminum fins.*

If necessary to use a chemical cleaner or detergent use a cleaner that does not contain any hydrofluoric acids and is between 7 and 8 on the pH scale. Ensure dilution instructions provided by the detergent supplier are followed. In case of doubt about the compatibility of the detergent with the type of materials listed above, always ask the supplier a written confirmation of the compatibility. Should a chemical cleaner be required, it is MANDATORY that all components are thoroughly rinsed with water even if the instructions of the cleaner specify that it is a “no rinse” cleaner. Failure to comply with above mentioned guidelines will lead to a shortened life of the equipment to an indeterminable degree. The repeated transportation of meat and fish waste can cause extensive corrosion to the evaporator coils and evaporator section tubing over time due to ammonia formation and can reduce the lifespan of the coils. Appropriate additional measures should be taken to protect the coils against the aggressive corrosion that can result from transportation of such products.

**Load Compartment:** Inspect the interior and exterior of the truck for any damage. Any damage to the walls or insulation should be repaired.

**Defrost Drains:** Check the defrost drain hoses and fittings to ensure they are not blocked.

**Doors:** Verify doors and weather seals are in good condition and seal hermetically.

**Sight glass:** Check that the refrigerant charge sight glass on the running unit is totally full (the cargo compartment temperature must be approximately 0°C).

## Weekly Post-Trip Checks

### **NOTICE**

#### **Equipment Damage!**

Do not use pressurised water.

1. Clean the outside cover of the unit. Use a damp cloth and neutral detergents. Do not use harsh cleaning products or solvents.
2. Check for leaks.

## Inspection and Service Intervals

3. Check for loose or missing hardware.
4. Check for physical damage to the unit.

### Inspection and Service Schedules

To ensure that your Thermo King unit operates reliably and economically over its full life, and to avoid limiting its warranty cover, the appropriate inspection and service schedule must be followed. Inspection and Service intervals are determined by the number of unit operating hours and by the age of the unit. Examples are shown in the table below. Your Dealer will prepare a schedule to suit your specific needs.

<b>Operat- ing Hours per Year</b>	<b>1000</b>	<b>2000</b>	<b>3000</b>
Inspection	6 months/ 500 hours		
Inspection	12 months/ 1000 hours (+ preventative maintenance)	6 months/ 1000 hours	4 months/ 1000 hours
Inspection	18 months/ 1500 hours	12 months/ 2000 hours (+ preventative maintenance)	8 months/ 2000 hours
Full Service	24 months/ 2000 hours	18 months/ 3000 hours	12 months/ 3000 hours (+ preventative maintenance)
	(continue as above)	(continue as above)	(continue as above)

### Service Record

Each inspection and service performed should be recorded on the Service Record Sheet found at the back of this manual.

### Preventative Maintenance

Refer to the previous page for checks that should be carried out daily/weekly on the unit. Please work with your Dealer in order to create a maintenance schedule which fits your needs.

Thermo King has extended the limited warranty on new units from 3,000 total hours to a maximum of 4,000 compressor run hours within the 2 year warranty period.



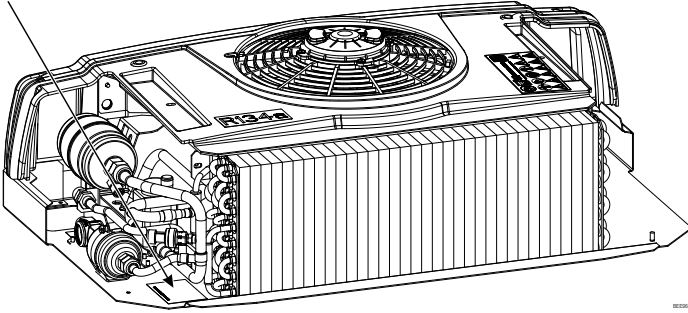
## Inspection and Service Intervals

---

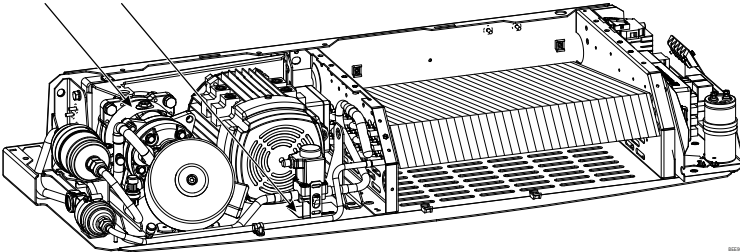
This limited warranty is dependent on the owner and/ or operator adhering to the preventative maintenance schedule as advised by your Thermo King Dealer.

# Serial Number Locations

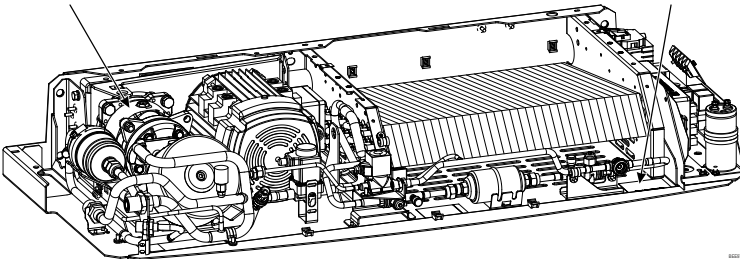
**Figure 15. V-100 Condenser, Serial Number Location**



**Figure 16. V-200 V-300 Condenser and Standby Compressor, Serial Number Locations**



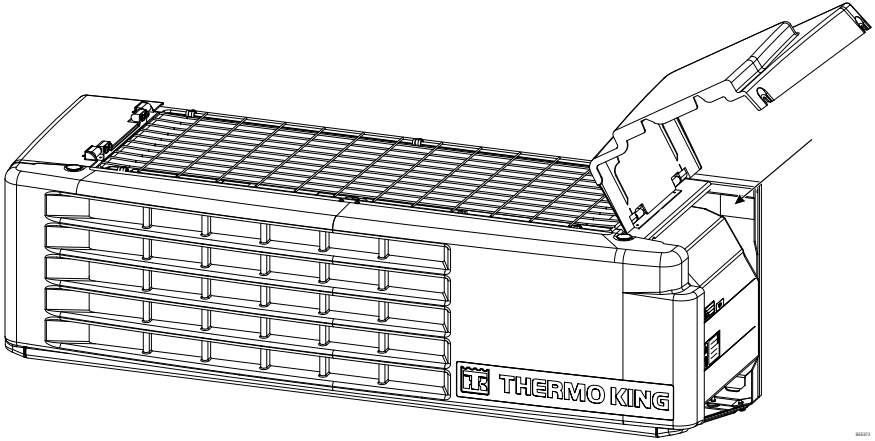
**Figure 17. V-200 V-300 SPECTRUM Condenser and Standby Compressor, Serial Number Locations**



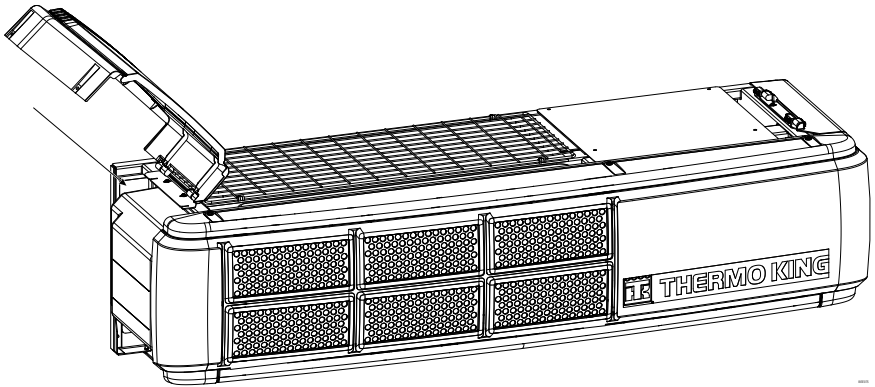
## Serial Number Locations

---

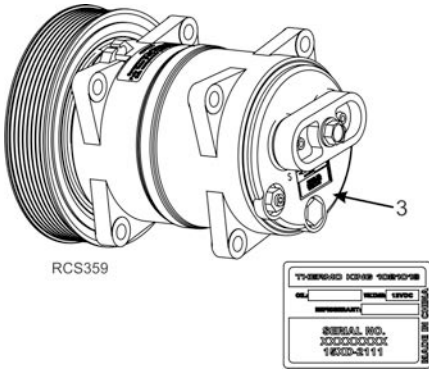
**Figure 18. V-500 V-600 Condenser, Serial Number Location**



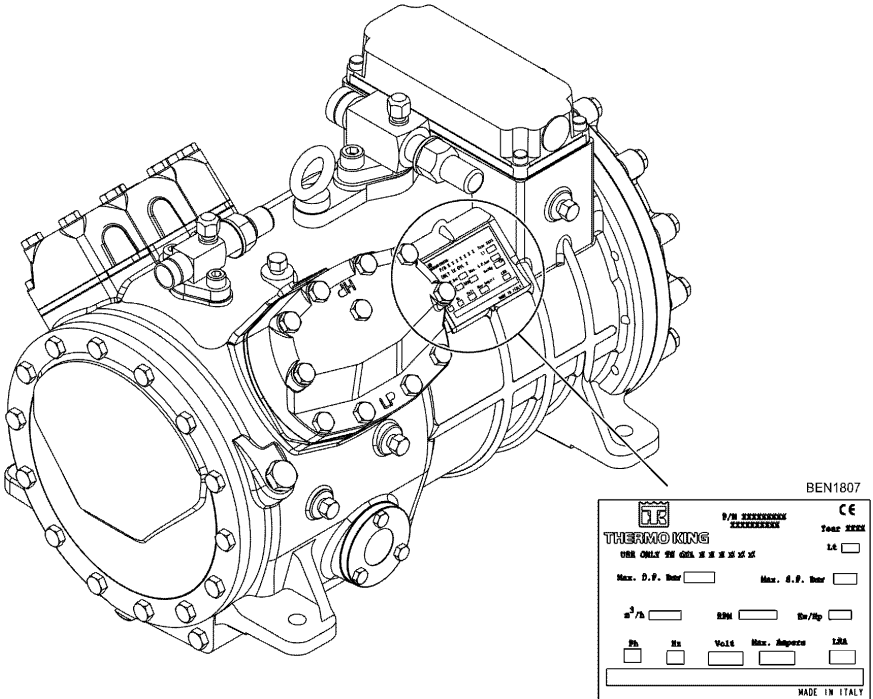
**Figure 19. V-800 V-1000 Condenser, Serial Number Location**



**Figure 20. Engine Driven Compressor Serial Number Location**



**Figure 21. Standby Compressor Serial Number Location**



## Recover Refrigerant

At Thermo King®, we recognize the need to preserve the environment and limit the potential harm to the ozone layer that can result from allowing refrigerant to escape into the atmosphere.

We strictly adhere to a policy that promotes the recovery and limits the loss of refrigerant into the atmosphere.

In addition, service personnel must be aware of Federal regulations concerning the use of refrigerants and the certification of technicians. For additional information on regulations and technician certification programs, contact your local THERMO KING dealer.









Thermo King – by Trane Technologies (NYSE: TT), a global climate innovator – is a worldwide leader in sustainable transport temperature control solutions. Thermo King has been providing transport temperature control solutions for a variety of applications, including trailers, truck bodies, buses, air, shipboard containers and railway cars since 1938. For more information, visit [www.thermoking.com](http://www.thermoking.com) or [www.tranetechnologies.com](http://www.tranetechnologies.com).

Thermo King has a policy of continuous product and product data improvements and reserves the right to change design and specifications without notice. We are committed to using environmentally conscious print practices.